

RED JACKET®

PRODUCT GUIDE

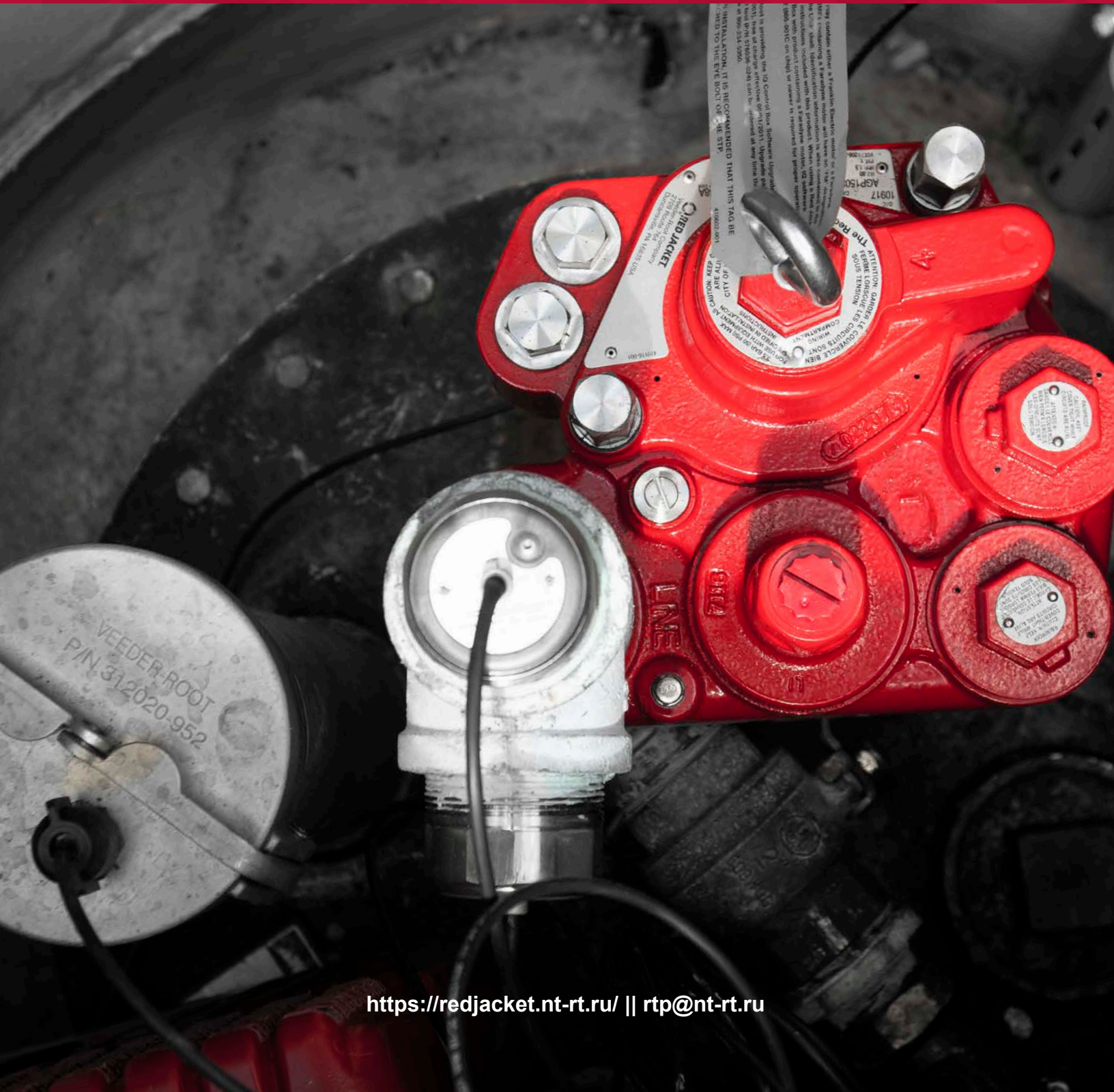

Архангельск (8182)63-90-72
Астана (7172)727-132
Астрахань (8512)99-46-04
Барнаул (3852)73-04-60
Белгород (4722)40-23-64
Брянск (4832)59-03-52
Владивосток (423)249-28-31
Волгоград (844)278-03-48
Вологда (8172)26-41-59
Воронеж (473)204-51-73
Екатеринбург (343)384-55-89
Иваново (4932)77-34-06

Ижевск (3412)26-03-58
Иркутск (395)279-98-46
Казань (843)206-01-48
Калининград (4012)72-03-81
Калуга (4842)92-23-67
Кемерово (3842)65-04-62
Киров (8332)68-02-04
Краснодар (861)203-40-90
Красноярск (391)204-63-61
Курск (4712)77-13-04
Липецк (4742)52-20-81
Киргизия (996)312-96-26-47

Магнитогорск (3519)55-03-13
Москва (495)268-04-70
Мурманск (8152)59-64-93
Набережные Челны (8552)20-53-41
Нижний Новгород (831)429-08-12
Новокузнецк (3843)20-46-81
Новосибирск (383)227-86-73
Омск (3812)21-46-40
Орел (4862)44-53-42
Оренбург (3532)37-68-04
Пенза (8412)22-31-16
Казахстан (772)734-952-31

Пермь (342)205-81-47
Ростов-на-Дону (863)308-18-15
Рязань (4912)46-61-64
Самара (846)206-03-16
Санкт-Петербург (812)309-46-40
Саратов (845)249-38-78
Севастополь (8692)22-31-93
Симферополь (3652)67-13-56
Смоленск (4812)29-41-54
Сочи (862)225-72-31
Ставрополь (8652)20-65-13
Таджикистан (992)427-82-92-69

Сургут (3462)77-98-35
Тверь (4822)63-31-35
Томск (3822)98-41-53
Тула (4872)74-02-29
Тюмень (3452)66-21-18
Ульяновск (8422)24-23-59
Уфа (347)229-48-12
Хабаровск (4212)92-98-04
Челябинск (351)202-03-61
Череповец (8202)49-02-64
Ярославль (4852)69-52-93

<https://redjacket.nt-rt.ru/> || rtp@nt-rt.ru





▶ TABLE OF CONTENTS

Overview	System Solutions	2
	The Red Jacket STP Key Benefits	3
	Superior Product Performance	4
	Components of The Red Jacket STP	5
	Ordering Guide	6-7
	Testing and Certification of the Industry's Most Advanced Motor	8
	Quality, Customer Service and Technical Support	9
Fuel	The Red Jacket Product Portfolio	10-11
	The Red Jacket 4" STP Portfolio	12
	Fuel Compatibility	13
	The Red Jacket STP	14-15
	The Red Jacket Alcohol Gas STP	16-17
	Red Armor® STP	18-19
	2+2 The Red Jacket Fixed Speed STP	20
	Virtual Siphon - Automation	21
	Maxxum STP	22
	CoreDEF™ STP	23-24
DEF	Site Configuration	25
	The Red Jacket DEF Pump	26
	LPG Premier STP	27
Corrosion	Combat Corrosion	28
	Sump-Dri™ Desiccant System	29-30
	The Red Jacket Stainless Steel Riser Pipes	31
	Trapper Intake Screen	32
Control	Control Boxes	33
	IQ Smart Control Box	34
	The Red Jacket 2 HP STP Fixed Speed Conversion Kit	35
	FXV Series Mechanical Line Leak Detectors	36
	Electronic Pressurized Line Leak Detection System	37
	Vacuum Breaker	38



System Solutions

The Hub of Site Operations

Veeder-Root is a leading global supplier of fuel management solutions with a tradition of excellence in the fueling industry. Our products improve profitability and abate risk for customers by delivering solutions to manage on-site operations, compliance reporting, fuel procurement, inventory reconciliation, and accounting processes. Veeder-Root products and services are installed in over 500,000 tanks globally and responsible for 22 billion gallons of gasoline and diesel fuel annually.

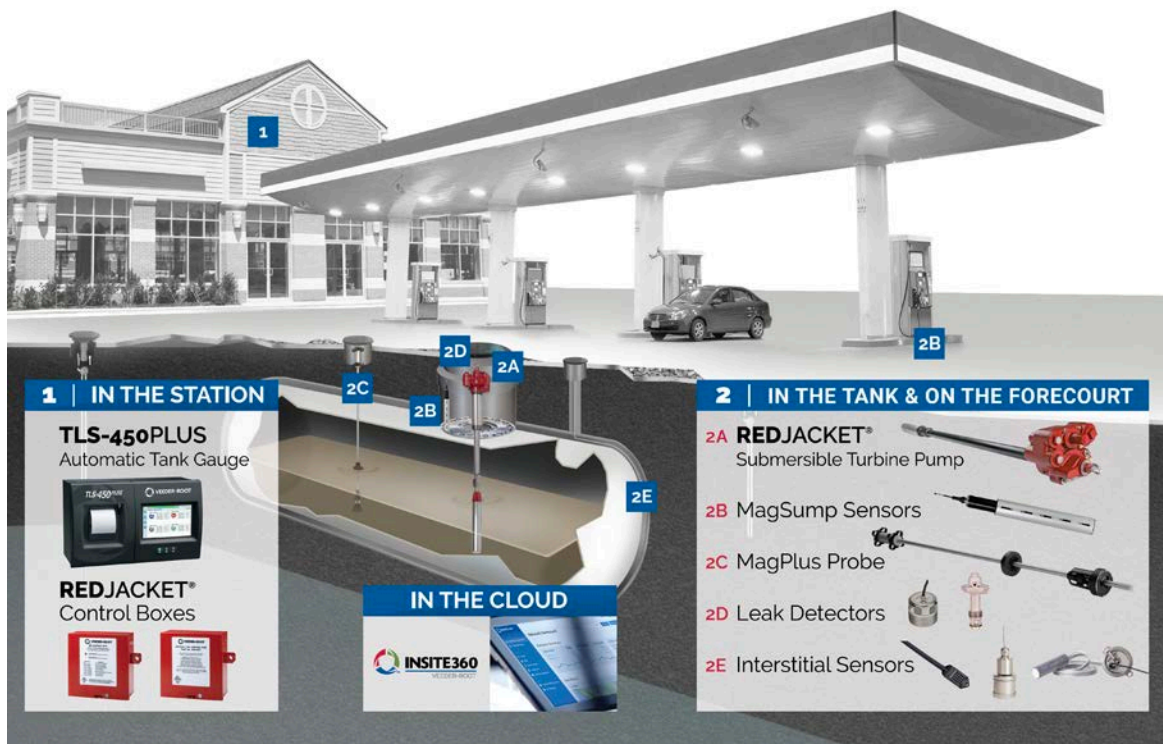

ADVANCED FUEL MANAGEMENT

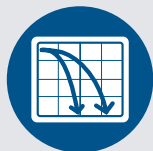

Flow Optimization

Monitor demand at the site and stage on additional pumps to ensure optimal fuel flow at all demand conditions.



System Redundancy

Manifold together two Red Jacket Submersible Turbine Pumps (STPs) at sites with high demand to ensure flow rates and the ability for pumps to back each other up.



Inventory Optimization

Configure your fueling system to optimize inventory using multiple settings for dispensing fuel from the storage tanks.



Connectivity

Connect to your TLS-450PLUS Automatic Tank Gauge (ATG) to activate tanks based on fuel height in line manifolded tanks.



The Red Jacket STP Key Benefits

The Red Jacket® STP

The Red Jacket is a Submersible Turbine Pump (STP) solution that optimizes fuel flow and dispensing. Red Jacket motor performance delivers higher flow rates than any other motor in the industry. Its advanced packer manifold design makes it the industry's easiest and safest STP to install and service. Available in ¾ HP to 2 HP configurations and fixed or variable Quick Set® lengths. As a Veeder-Root flagship product line, Red Jacket is backed by the largest network of distributors and authorized service contractors worldwide.



WHY CHOOSE THE RED JACKET



Owner/Operator

- ▶ **Most Reliable**
Minimal Downtime.
- ▶ **Lowest Total Cost Ownership (TCO)**
Affordable to Buy, Own and Operate.
- ▶ **Improve Inventory Management**



Distributor

- ▶ **Industry's Most Reliable**
Satisfied Customers.
- ▶ **Lower Purchase Cost**
Stay Competitive.
- ▶ **Hydraulic Hammer**
No Concern.



Contractor

- ▶ **Simple Installation**
Easy to Service.
- ▶ **Low Cost Controller**
Affordable to Stock.
- ▶ **No Electrical Interference**
Avoid Signal Conflicts.

Superior Product Performance

Unitized Motor and Pump (UMP)



▶ PERFORMANCE

- High efficiency.
- Maximum flow output.
- Reduced power consumption.

▶ SAFETY

- Further separation of connectors helps meet most demanding flameproof standards.

▶ PROVEN RELIABILITY

- Industry proven lower field failure rates.
- Improved bearing design and upgraded insulation yield longer motor life.

▶ INDUSTRY EXPERTISE

- Our superior motor design delivers higher efficiency, fuel flow and lower power consumption, allowing Red Jacket to continue to offer the most advanced STPs.

The Red Jacket Packer Manifold

▶ FAST INSTALLATION AND SIMPLE SERVICE AND TESTING

- Spring mechanisms reduce lifting force during maintenance.
- Automatic electrical disconnect for safety during maintenance.
- Automatic fuel drain to avoid product spillage during maintenance.
- Contractor's Box and Capacitor Housing are isolated from the fuel path and integrated into the packer manifold to improve safety.
- Easier line tests and servicing with unique check valve design.
- Two vacuum ports support applications requiring multiple vacuum connections.





The Red Jacket® STP

Components of The Red Jacket STP

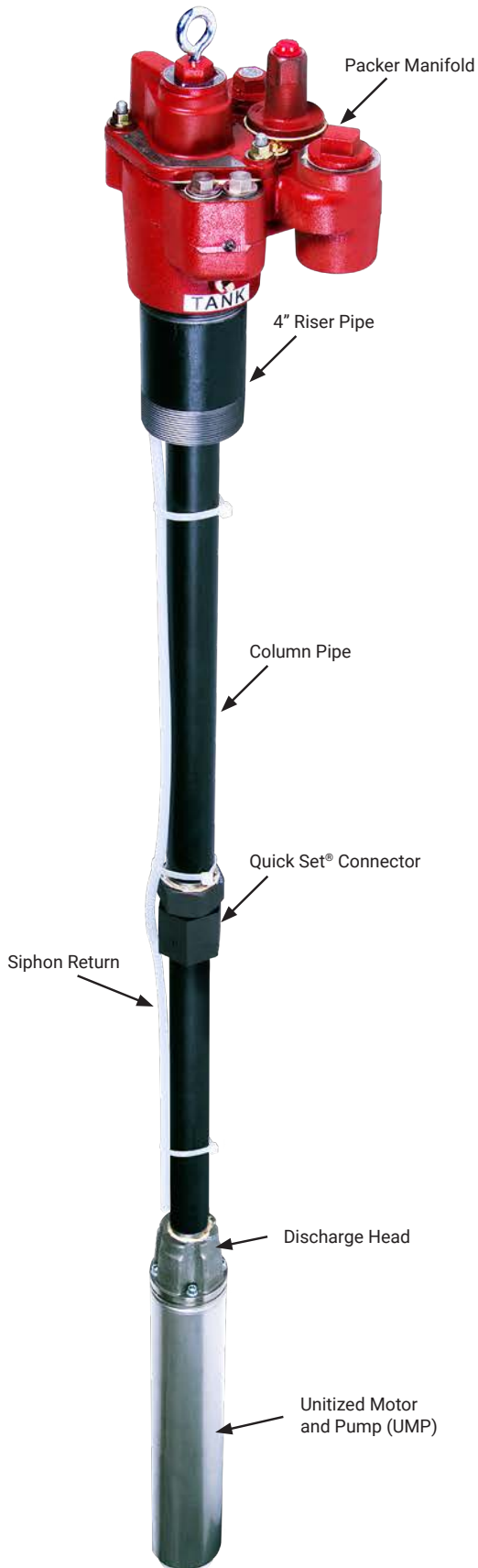

Packer Manifold

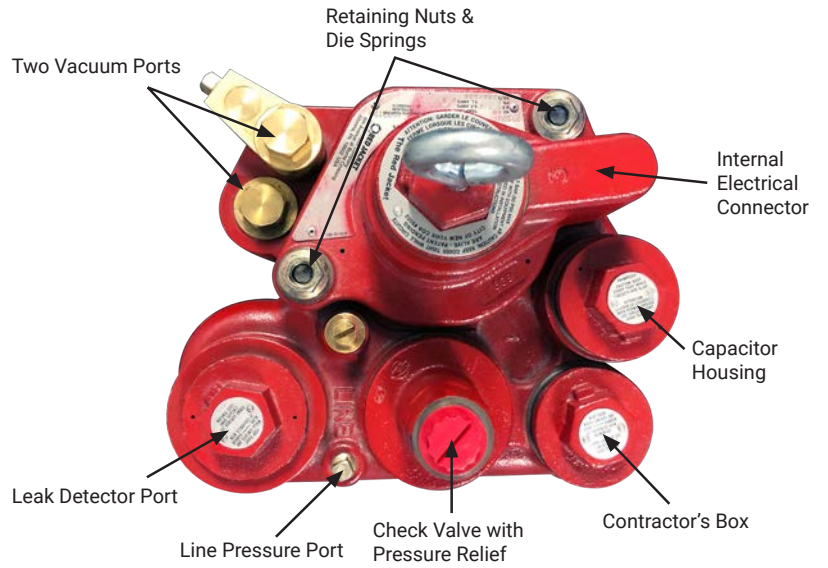

Unitized Motor and Pump (UMP)

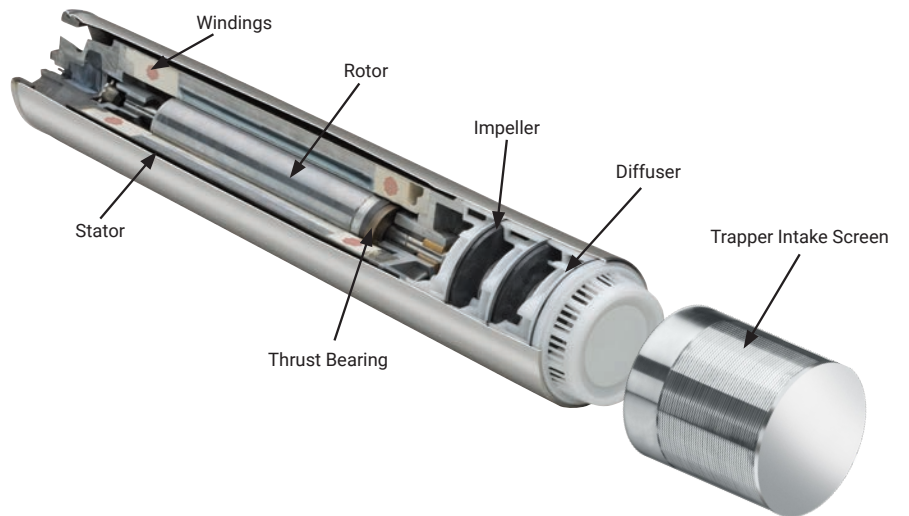

Ordering Guide

Red Jacket's unsurpassed expertise helps sites optimize fuel flow. Part of the industry's leading Veeder-Root suite of products, Red Jacket's family of Submersible Turbine Pumps and Pump Controllers ensures that sites can pump fuel quickly, efficiently and safely – whether it's motor fuel, diesel, aviation gasoline, liquid petroleum gas, ethanol/methanol or kerosene – in aboveground or underground storage tanks.

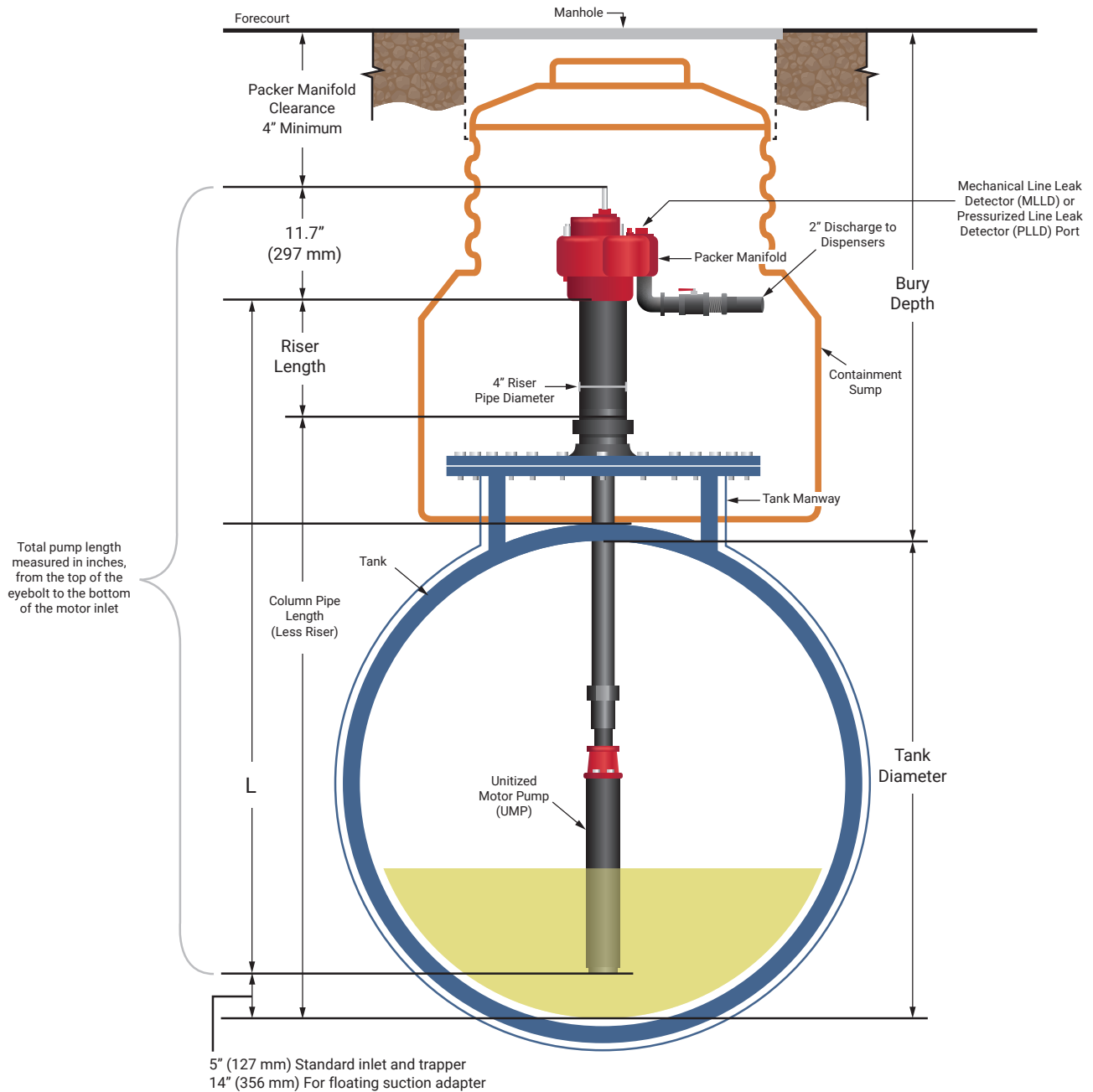



Ordering Guide

The Red Jacket® STP portfolio has seven components that make up its different model numbers, for a variety of options depending on your specific site needs:

1. Pump Type
2. Horse Power
3. Pump Design Code
4. Electrical Code
5. Number of Stages (Impellers)
6. Quick Set® Options

MODEL IDENTIFICATION

Example: **AGP 200 S 1 -3 RJ2**

PUMP TYPE

P	= Petroleum
PL	= Petroleum Low Pressure*
AGP	= Alcohol
AGPL	= Alcohol Low Pressure*
X3P	= 3 Impeller Petroleum**
X4P	= 4 Impeller Petroleum**
X3AGP	= 3 Impeller Alcohol**
X4AGP	= 4 Impeller Alcohol**
NOTE: *2.00 Horsepower Only	
NOTE: **1.50 Horsepower Only	

HORSE POWER

75	= .75 (3/4)
150	= 1.50 (1 1/2)
200	= 2.00 (2)
300	= 3.00 (3)
500	= 5.00 (5)

PUMP DESIGN CODE

S	= Alcohol Gas Fixed Speed
U	= Non Alcohol Gas Fixed Speed

ELECTRICAL CODE

0	1 Phase	60 Hz	115 V	11	3 Phase	50 Hz	346V
1	1 Phase	60 Hz	208/230V	12	3 Phase	50 Hz	220V
1	1 Phase	60 Hz	230V	13	3 Phase	50 Hz	200V
2	1 Phase	50 Hz	110/120V	14	3 Phase	60 Hz	200V
3	1 Phase	50 Hz	220/230V	15	3 Phase	50 Hz	440V
4	3 Phase	60 Hz	208/230V	16	3 Phase	50 Hz	415V
4	3 Phase	60 Hz	230V	17	3 Phase	50 Hz	380V
5	3 Phase	60 Hz	460V	18	3 Phase	60 Hz	400V
6	3 Phase	60 Hz	550/575V	19	3 Phase	60 Hz	380V
7	1 Phase	60 Hz	208V	20	3 Phase	100 Hz	230V
8	3 Phase	60 Hz	208V	21	1 Phase	50 Hz	230V
9	3 Phase	50 Hz	380/415V	22	3 Phase	50 Hz	400V
10	1 Phase	50 Hz	200V				

QUICK SET® LENGTH OPTIONS

Blank	= Fixed Length Pump
RJ1	= (74.5" - 105") The Red Jacket
RJ2	= (104.4" - 165") The Red Jacket
RJ3	= (164" - 225") The Red Jacket
RA1	= (74.5" - 105") The Red Armor®
RA2	= (104.4" - 165") The Red Armor
RA3	= (164" - 225") The Red Armor
NOTE: *Assumes 1.5 HP	

NUMBER OF STAGES (IMPELLERS)

Blank	= 2 Stages
-2	= 2 Stages
-3	= 3 Stages
-4	= 4 Stages
-19	= 19 Stages
-21	= 21 Stages
-24	= 24 Stages
NOTE: Not used with "X" series pumps	

Testing and Certification of the Industry's Most Advanced Motor

In-House Performance Testing and Manufacturing

Our manufacturing facilities focus on product reliability to ensure superior performance and dependability for all of our Red Jacket® Submersible Turbine Pumps. Maintaining high standards throughout the manufacturing process ensures our Red Jacket products continually and consistently meet your on-site fueling infrastructure needs.



To ensure proper performance, our engineering facilities perform a multitude of check-points and testing protocols to maintain our high levels of performance expectations:

- Endurance testing using various fuel types, including, for example, gasoline, diesel, ethanol based fuels, biodiesels, and Diesel Exhaust Fluid (DEF), which reflect real world pumping applications.
- Hydraulic performance testing using gasoline, diesel fuel, DEF or Liquid Petroleum Gas (LPG) as the test fuel, which reflects real world fuels.
- Motor performance testing ($\frac{3}{4}$ HP up to 5 HP) to determine amperage, efficiency and temperature ratings.
- Electronic and mechanical leak detection testing (3 GPH and precision) uses steel, fiberglass and flex pipe lines, which ensures compliance to EPA and/or any other regulatory leak detection performance standards.
- All instrumentation is calibrated in compliance to ISO/IEC 17025 to ensure measurements are accurate and will meet or exceed UL Data Acceptance Program requirements for in-house UL, IECEx and ATEX certification testing.
- Data Acquisition using LabVIEW measurement instrumentation to continuously monitor and control testing.
- Thermal cycling to assess a wide range of temperatures, representing various geographic climate applications.
- Fuel compatibility of elastomers and plastics (static and dynamic) in various test fuels.
- Hydrostatic testing of castings to ensure designs have four times safety margin.



Trusted Technical Expertise

Delivering World-Class Customer Service

- Providing transactional accuracy to ensure customer product delivery satisfaction
- Quick-turn responsiveness to ensure customer inquiries are handled expeditiously and professionally

Providing Exceptional Technical Support

- Dynamic and knowledgeable support team with over 80+ years of collective expertise in the fueling infrastructure industry
- Fielding, trouble-shooting and resolving customer inquiries, installation and compliance questions
- Providing top-notch industry know-how in guiding customers toward selecting the right equipment for the right application

Ensuring Exceptional Quality Standards

- Maintain Veeder-Root's ISO 9001:2015 Registered Quality Management System to ensure product quality standards
- Assure Veeder-Root's products are manufactured in compliance with UL/cUL Listings and the ATEX Directive
- Continuous monitoring of Veeder-Root's product performance in the field

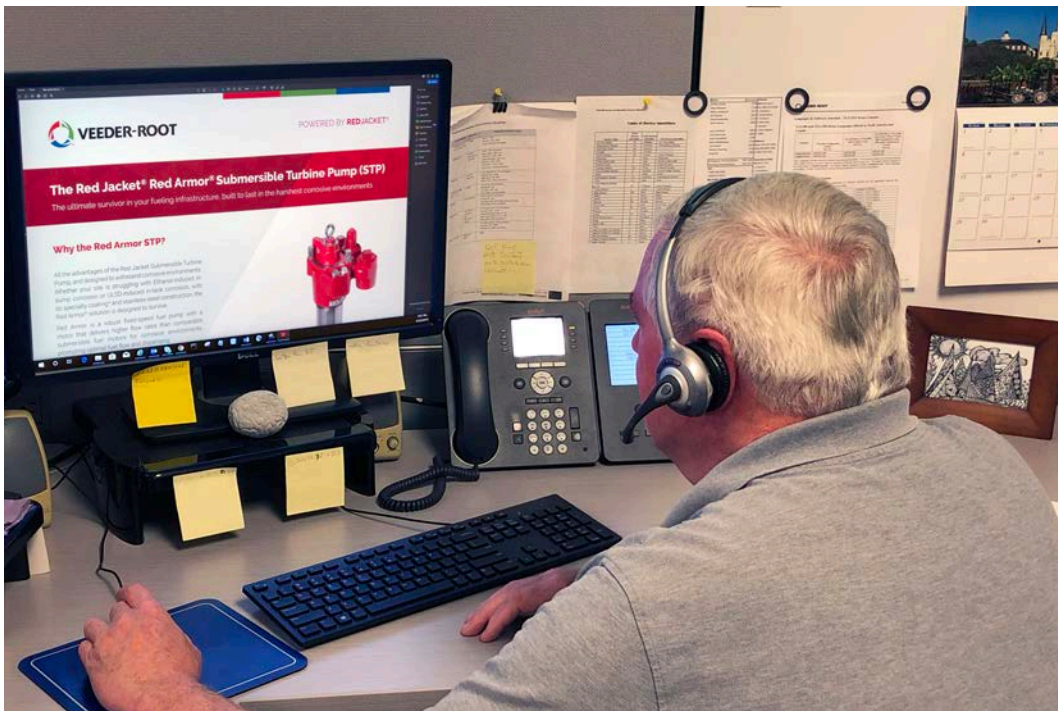



The Red Jacket Product Portfolio



4" Pumps

- The Red Jacket STP
- The Red Jacket AG STP
- The Red Armor STP

Pages 12 - 21



Maxxum 6" High Capacity Pumps

- The Red Jacket 3 HP Maxxum Pump
- The Red Jacket 5 HP Maxxum Pump

Page 22

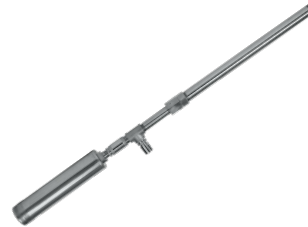

Diesel Exhaust Fluid (DEF) Pumps

- The Red Jacket CoreDEF™ STP
- The Red Jacket DEF Pump

Pages 23 - 26



Liquefied Petroleum Gas (LPG) Pumps

- The Red Jacket LPG Premier Pump
- The Red Jacket LPG Premier MidFlow Pump
- The Red Jacket LPG Premier HiFlow Pump

Page 27



Combat Corrosion Accessories

- Sump-Dri™ Desiccant System
- The Red Jacket Stainless Steel Riser Pipes
- The Red Jacket Trapper Intake Screen

Pages 28 - 32



Control Boxes

- The Red Jacket Standard Control Box
- The Red Jacket ISOTROL™ 1-8 Control Box
- The Red Jacket IQ Smart Control Box

Pages 33 - 35



Leak Detection

- FXV Series Mechanical Line Leak Detectors
- Electronic Pressurized Line Leak Detection System

Pages 36 & 37



Vacuum Breaker

- The Red Jacket Vacuum Breaker

Page 38

The Red Jacket 4" STP Portfolio

The Red Jacket 4" STP Platform

The Red Jacket Submersible Turbine Pump (STP) platform delivers faster, more reliable fuel flow for the lowest cost of ownership. With a motor that delivers higher flow rates than any other motor in the industry, The Red Jacket STPs optimize fuel flow to your dispensers. It features Red Jacket's advanced packer manifold design, making it the fueling industry's easiest and safest submersible pump to install and service.



The Red Jacket STP

The Red Jacket STP solution optimizes fuel flow and dispensing. The Red Jacket's motor performance delivers higher flow rates than comparable submersible fuel motors. The STP also features Red Jacket's advanced packer manifold design, making it the industry's easiest and safest STP to install and service.



The Red Jacket Alcohol Gas (AG) STP

All the advantages of The Red Jacket STP, designed for alternative fuels – such as alcohol and ethanol. Red Jacket Submersible Turbine Pump AG is a fixed-speed alcohol gas fuel pump with a motor that delivers a higher flow rate than comparable submersible fuel motors, to optimize fuel flow and dispensing.



The Red Armor® STP

All the advantages of The Red Jacket STP, and now designed to withstand corrosive environments. Whether your site is struggling with Ethanol-induced in-sump corrosion or ULSD-induced in-tank corrosion, with its specialty coating* and stainless-steel construction, the Red Armor solution is designed to survive.

** Red Armor's specialty coating is the toughest performer across a battery of abrasion, immersion and impact standards.*



Fuel Compatibility

As Biofuels, Vehicle Technology and Biofuel Infrastructures Expand, so do the Needs of Your Fueling Systems.

If your fueling system is used with incompatible fuel types, infrastructure degradation and corrosion could result. Therefore, as fuels containing higher amounts of ethanol (such as E15 and E85) and biodiesels are added to fueling sites, it is important in the design phase of new sites and during upgrades to existing sites to consider STPs that are compatible with renewable fuels, as well as fuels focused on improved emissions and fuel economy. The Red Jacket® STP portfolio offers solutions tailored for both traditional and renewable fuels and provides protection against corrosive environments.



The Red Jacket STP

The cornerstone of your fueling infrastructure, The Red Jacket STP solution optimizes fuel flow and dispensing. It is the foundation model that sets the standard for high throughput, high reliability fueling applications.

Compatible with:

- 100% Diesel or Gasoline
- Ethanol, Methanol, MTBE, ETBE, or TAME concentrations up to 20%

Protection Level:



The Red Jacket Alcohol Gas (AG) STP

The Red Jacket AG STP has an additional 30% increase in stainless steel hardware from The Red Jacket STP. It has all the advantages of The Red Jacket STP design, but was constructed with stainless steel on all parts exposed to the fuel path.

In addition to fuel types supported by The Red Jacket STP, The Red Jacket AG STP is also compatible with:

- Methanol concentrations up to 100%
- Ethanol concentrations up to 90%
- Biodiesel concentrations up to 100%
- Jet Fuel and AVGAS
- Kerosene and Fuel Oil

Protection Level:



The Red Armor® STP

The Red Armor STP has an additional 30% increase in stainless steel hardware from The Red Jacket AG STP. It has all the advantages of The Red Jacket STP design, but was constructed specifically to withstand corrosive environments.

The Red Armor STP is compatible with the same fuel types as The Red Jacket STP and AG STP, but also protects against:

- Microbial Growth in Tank (Ultra-Low Sulfur Diesel)
- Constant Moisture Presence or Water Ingress into Sump
- Known Corrosive Environment

Protection Level:





The Red Jacket STP



Advanced STP Design

The Red Jacket STP solution optimizes fuel flow and dispensing. Its motor performance delivers higher flow rates than comparable submersible fuel motors. The STP also features Red Jacket's advanced packer manifold design, making it the industry's easiest and safest STP to install and service. This STP solution is available in ¾ HP to 2 HP motor configurations and fixed or Quick Set® adjustable lengths.

Red Jacket's unsurpassed expertise helps your customers optimize fuel flow. Part of the industry's leading Veeder-Root suite of products, Red Jacket's family of Submersible Turbine Pumps (STPs) and Pump Controllers ensure that your customers can pump fuel quickly, efficiently and safely – whether it's motor fuel, diesel, aviation gasoline, ethanol/methanol or kerosene – in aboveground or underground storage tanks.

► KEY FEATURES

Superior Motor Design:

- **Up to 5% Increased Flow** – Improved stator and receptacle housing design provides larger fuel paths.
- **8% Less Power Consumption** – More efficient motor design results in 8% reduction in wattage.
- **Better Quality** – Red Jacket's motor manufacturing yields improved quality, which means more station uptime than other STPs on the market.
- **Universal Compatibility** – Fewer parts to stock.
- **Improved Reliability** – Improved bearing design and upgraded insulation yield longer motor life.
- **Increased Safety** – Enhanced connectors separation meets latest flameproof standards.

Advanced Packer Manifold Design:

- **Built-in Isolated Contractor's Box** – Electrical connection housing is built into the manifold and is completely isolated from the fuel path.
- **Easy to Install and Service** – No adjustment required to fit yoke, assembly is quick.
- **Increased Electrical Safety** – Automatic electrical yoke disconnects upon removal of extractable bolts.
- **Environmentally Friendly** – Automatic breaking of extractable seal upon bolt removal ensures automatic fuel drain back into tank, protecting the environment from contamination and site owners from related liability.
- **Innovative Check Valve Design** – "Open" setting makes for easier line tests and servicing.

Protection Level





Product Specifications

Fuel Compatibility:

- 100% Diesel or Gasoline
- Ethanol, Methanol, MTBE, ETBE or TAME concentrations up to 20%

Motor Sizes Available:

- ¾ HP, 60 Hz, 1-phase
- 1 ½ HP, 60 Hz, 1-phase
- X3 1 ½ HP, 60 Hz, 1-phase, high pressure
- LP 2 HP, 60 Hz, 1-phase, low pressure
- 2 HP, 60 Hz, 1-phase

Protective Coatings: N/A

Operation Environment:

- Class 1, Group D atmospheres
- Low corrosion environment
- Dry sump space (no water ingress)

Installation Depth Range:

- Fixed Length: 3.5' to 19'
- Quick Set® (Adjustable Length):
 - RJ 1 = 74.5" - 105"*
 - RJ 2 = 104.4" - 165"
 - RJ 3 = 164" - 225"

*Assumes 1.5 HP

Packer Manifold Access Ports:

- Siphon Ports:
 - 2 available, ¼" NPT
 - Vacuums generated up to 25 in Hg
- Line Pressure Port: 1 Available, ¼" NPT
- Vent Port: 1 Available, ¼" NPT

Check Valve Compatibility:

- Standard VR ready check valve for PLLD (410152-001)
- High pressure check valve for high pressure applications (410152-002)

Performance @ 230V; SG = 0.78

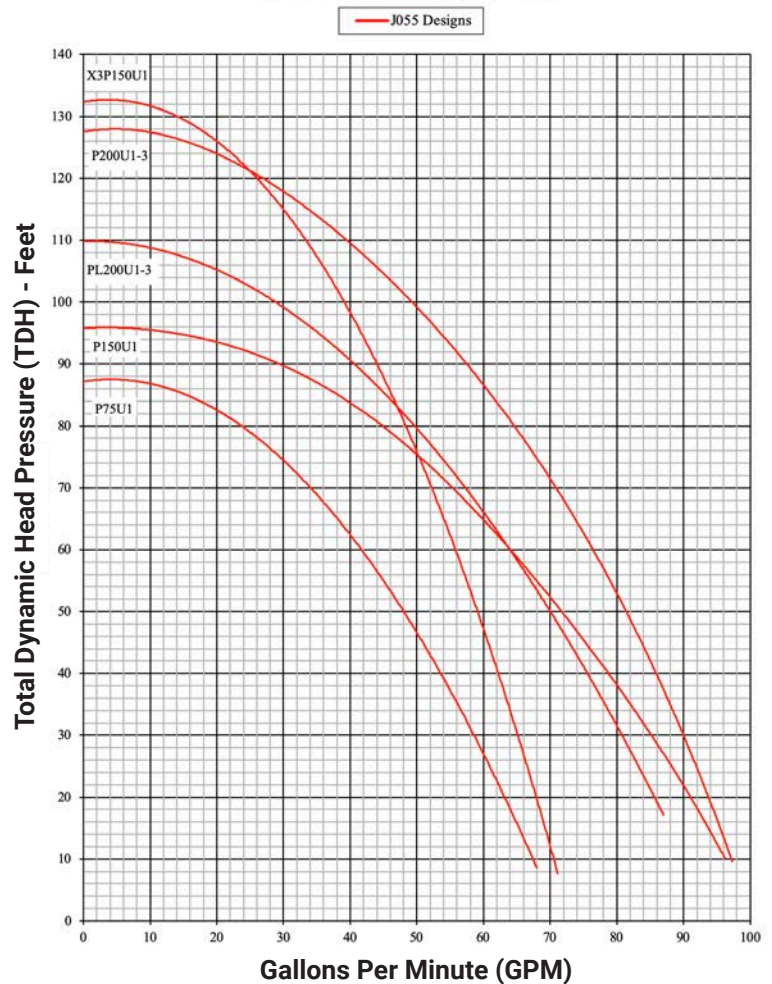

UL Listings:

- 100% Diesel
- 100% Gasoline
- Gasoline and up to: 10% Ethanol, 15% Methanol, 20% MTBE, 20% ETBE, 20% TAME

Other Agency Listings: cUL

The Red Jacket Alcohol Gas STP



Created for Alternate Fuels

All the advantages of The Red Jacket STP, designed for alternative fuels – such as alcohol and ethanol. The Red Jacket AG STP is a fixed-speed alcohol gas fuel pump with a motor that delivers a higher flow rate than comparable submersible fuel motors, to optimize fuel flow and dispensing. The STP also features Red Jacket’s advanced packer manifold design, making it the industry’s easiest and safest STP to install and service. This STP solution is available in ¼ HP to 2 HP motor configurations and fixed or Quick Set® adjustable lengths.

▶ KEY FEATURES

Alternative Fuel ready with AG Compatible Hardware:

- **Specialized Design** – Compatible with Alternate Fuels. Ethanol concentrations up to 90%, Methanol concentrations up to 100%, and MTBE, ETBE or TAME concentrations up to 20%.
- **Certified** – UL79A and UL79B for use with renewable biofuels.

Plus, all the Advantages of The Red Jacket STP Features



The Red Jacket AG STP is compatible with Ethanol concentrations up to 90%, Methanol concentrations up to 100%, and MTBE, ETBE or TAME concentrations up to 20%, and is UL79A and UL79B certified for use with renewable biofuels.

Protection Level





Product Specifications

Fuel Compatibility:

- 100% Diesel or Gasoline
- Biodiesel concentrations up to 100%
- Jet Fuel and AVGAS
- Kerosene and Fuel Oil
- Ethanol concentrations up to 90%
- Methanol concentrations up to 100%
- MTBE, ETBE or TAME concentrations up to 20%

Motor Sizes Available:

- ¾ HP, 60 Hz, 1-phase
- 1 ½ HP, 60 Hz, 1-phase
- X3 1 ½ HP, 60 Hz, 1-phase, high pressure
- LP 2 HP, 60 HZ, 1-phase, low pressure
- 2 HP, 60 Hz, 1-phase

Protective Coatings: N/A

Operation Environment:

- Class 1, Group D atmospheres
- Low corrosion environment
- Dry sump space (no water ingress)

Installation Depth Range:

- Fixed Length: 3.5' to 19'
- Quick Set® (Adjustable Length):
 - RJ 1 = 74.5" - 105"*
 - RJ 2 = 104.4" - 165"
 - RJ 3 = 164" - 225"

*Assumes 1.5 HP

Packer Manifold Access Ports:

- Siphon Ports:
 - 2 available, ¼" NPT
 - Vacuums generated up to 25 in Hg
 - Equipped with stainless siphon cartridge for survivability in corrosive fuels (410151-002)
- Line Pressure Port: 1 Available, ¼" NPT
- Vent Port: 1 Available, ¼" NPT

Check Valve Compatibility:

- Standard VR ready check valve for PLLD (410152-001)
- High pressure check valve for high pressure applications (410152-002)

Performance @ 230V; SG = 0.78

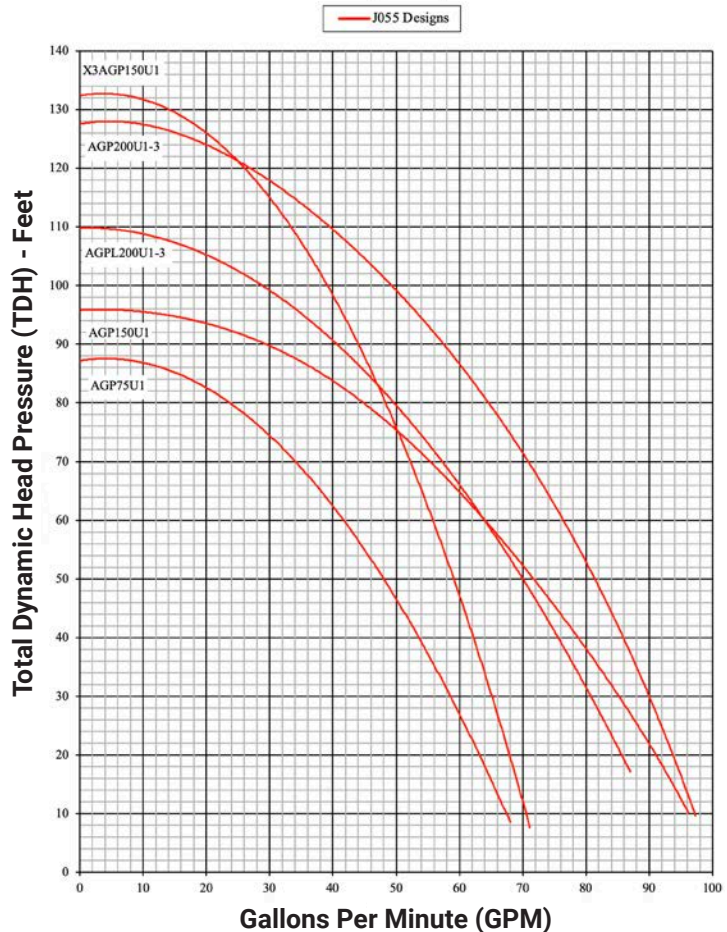

UL Listings:

- 100% Diesel
- 100% Gasoline
- 100% Biodiesel (B100)
- Kerosene and Fuel Oil
- 85% Ethanol (E85)
- 0-20% Biodiesel blends
- Gasoline and up to: 15% Methanol, 20% MTBE,
- 20% ETBE, 20% TAME

Other Agency Listings: cUL



Red Armor® STP



In-Sump and In-Tank Protection from Corrosion

The ultimate survivor in your fueling infrastructure, the Red Armor series of STPs is built to last in the harshest corrosive environments created by ULSD and ethanol blends. Red Armor is a robust fixed-speed fuel pump with a motor that delivers higher flow rates than comparable submersible fuel motors for corrosive environments, promoting optimal fuel flow and dispensing. The Red Armor STPs also features Red Jacket's advanced packer manifold design, making it the industry's easiest and safest STP to install and service. This STP solution is available in ¾ HP to 2 HP motor configurations and fixed or Quick Set® adjustable lengths.

The Red Armor family of STPs and Pump Controllers ensure that your customers can pump fuel quickly, efficiently and safely – whether it's motor fuel, diesel, aviation gasoline, ethanol/methanol or kerosene – in even the harshest aboveground or underground fueling environments.

► KEY FEATURES

Added Protection on all Exposed Surfaces:

- **Specialty coating** on all cast surfaces withstands acetic acid exposure to prevent pitting and deterioration over time.
- **Stainless Steel construction** on all exposed surfaces ensures easy maintenance for the life of the pump, including: riser, nuts, springs, screws, check valve seat, eye bolt, and check valve guide.
- **Constructed with upgraded materials** including powder-coated discharge head, stainless column pipe and Quick Set connector.

Plus, all the Advantages of The Red Jacket STP Features

Protection Level



**Red Armor's specialty coating is the toughest performer across a battery of abrasion, immersion and impact standards.*



Product Specifications

Fuel Compatibility:

- 100% Diesel or Gasoline
- Biodiesel concentrations up to 100%
- Jet Fuel and AVGAS
- Kerosene and Fuel Oil
- Ethanol concentrations up to 90%
- Methanol concentrations up to 100%
- MTBE, ETBE or TAME concentrations up to 20%

Motor Sizes Available:

- ¾ HP, 60 Hz, 1-phase
- 1 ½ HP, 60 Hz, 1-phase
- X3 1 ½ HP, 60 Hz, 1-phase, high pressure
- LP 2 HP, 60 Hz, 1-phase, low pressure
- 2 HP, 60 Hz, 1-phase

Protective Coatings: Exposed Cast Iron covered with specialized dual powder/e-coating

Operation Environment:

- Class 1, Group D atmospheres
- High corrosion environment
- Wet or dry sump space (water ingress)

Installation Depth Range:

- Fixed Length: 3.5' to 19'
- Quick Set® (Adjustable Length):
 - RJ 1 = 74.5" - 105"*
 - RJ 2 = 104.4" - 165"
 - RJ 3 = 164" - 225"

*Assumes 1.5 HP

Packer Manifold Access Ports:

- Siphon Ports:
 - 2 available, ¼" NPT
 - Vacuums generated up to 25 in Hg
- Line Pressure Port: 1 Available, ¼" NPT
- Vent Port: 1 Available, ¼" NPT

Performance @ 230V; SG = 0.78

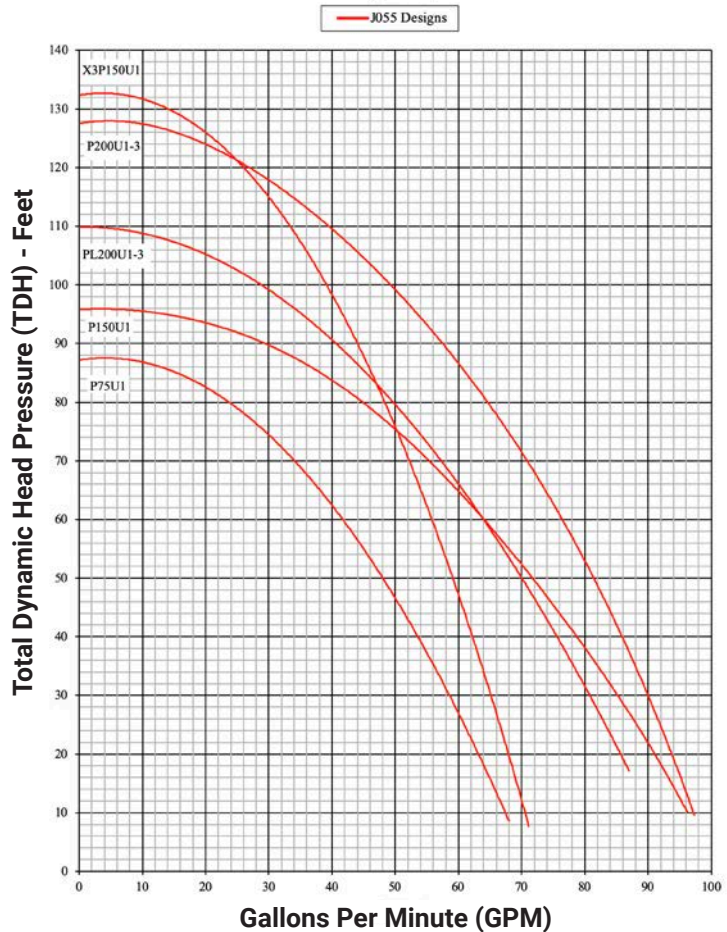

Check Valve Compatibility:

- Standard VR ready check valve for PLLD (410152-001)
- High pressure check valve for high pressure applications (410152-005)

UL Listings:

- 100% Diesel or Gasoline
- Gasoline and up to: 10% Ethanol, 15% Methanol, 20% MTBE, 20% ETBE, 20% TAME

Other Agency Listings: cUL

2+2 The Red Jacket Fixed Speed STP

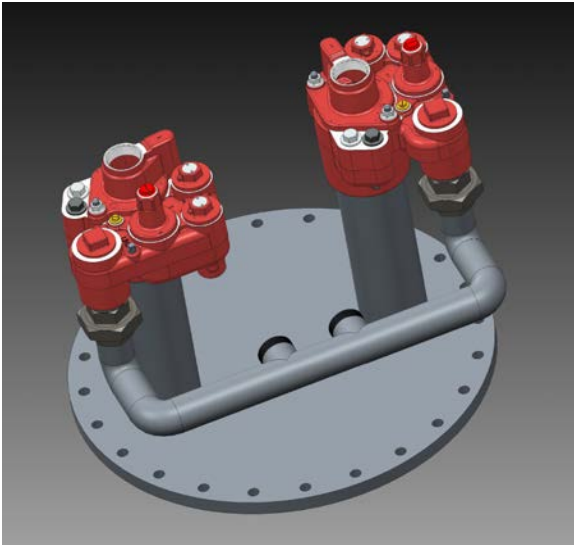

Line Manifolding & The Red Jacket 2+2 Solution

Increase pumping capacity by manifolded two Red Jacket STPs together in the sump and using Red Jacket IQ Control Boxes to stage the pumps on and off as demand needs dictate. For busy sites this allows them to keep pumping even while maintenance is being performed on one of the pumps.

Two fixed-speed 2 HP pumps manifolded together provide profit-saving protection against outage and better flow than a single 4 HP pump. The sump must be 42" in diameter or greater. When using a single 4 HP pump, a pump or controller failure brings down a fueling site. The 2+2 solution provides seamless redundancy and optimal flow for your site.

The 2+2 solution provides redundancy and backup operation with automatic failover. Switch-on-the-fly will switch STPs in live mode, without waiting for an on-hook condition, essential for maintaining balance at busy sites. Integrates control with Mechanical Line Leak Detection (MLLD) or Pressurized Line Leak Detection (PLLD).

▶ KEY BENEFITS

REDUNDANCY

The Key to Uptime:

- Automatic failover
- Service one STP while the other keeps your site running

EFFICIENCY

Working Smarter:

- 2+2 will produce 50% higher flow than a 4 HP variable-speed design
- Demand based staging to even wear and lower power consumption

STANDARDIZE

Streamline Inventory:

- One 2 HP pump, all applications

MLLD

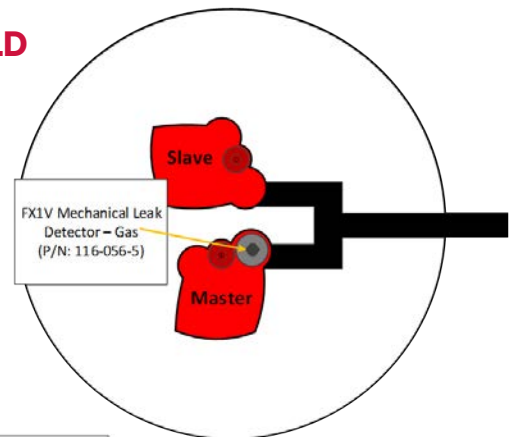

PLLD

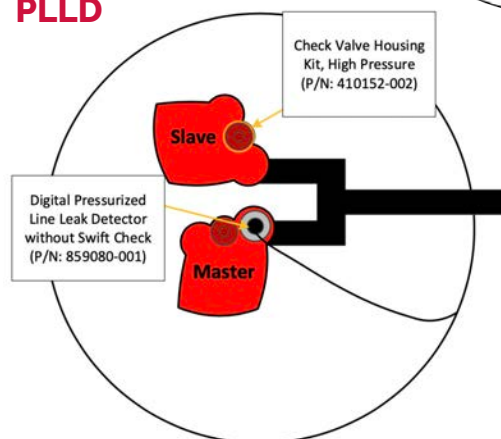



Automated Fuel Management

The TLS-450PLUS Automatic Tank Gauge (ATG) Virtual Siphon feature provides site operators the ability to control tanks' inventory levels based on operational needs.

Using a line manifold system with two or more tanks, allows the site operators to use the TLS-450PLUS ATG system to decide when to activate a specific tank based on the tanks fuel height, volume, or other setting specific to the pump configuration. In addition to this capability, the TLS-450PLUS will activate the unused tank while the other tank is still active to ensure no disruption of dispensing occurs during the tank switch over event.

With the Veeder-Root TLS-450PLUS ATG, Virtual Siphon is easy to program, monitor and maintain, and provides the site with STP redundancy and backup operation.

There are several modes for managing the fuel inventory in each tank:

- 1. Manifolded: Alternate-Volume or Alternate-Height** - The TLS-450PLUS alternates the pumps to maintain a volume or height differential.
- 2. Manifolded: Alternate Pump** - Pumps alternate until one tank is empty.
- 3. Manifolded: Sequential** - Pumps empty each tank one at a time.
- 4. Manifolded: All Pumps** - All pumps on until respective tanks are empty.

Virtual Siphon connects your TLS-450PLUS ATG to your Red Jacket STPs using the IQ and Isotrol Control Boxes.

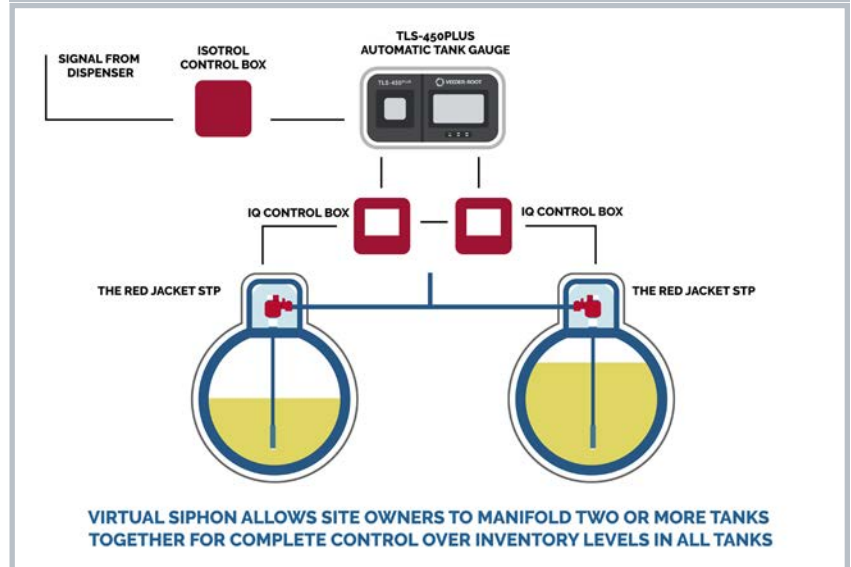

▶ KEY FEATURES

- Inventory and delivery reporting.
- Consolidated delivery information for easy fuel ordering.
- Maintain constant at the nozzle flow when switching from tank to tank.
- Programmable switch levels to reduce STP cycling.
- Continuous inventory monitoring with built in pump control logic.
- Alarm and warning notifications when fuel tanks require fuel delivery intervention.

Required Equipment: To take advantage of the Virtual Siphon feature customers must have the TLS-450PLUS ATG, Veeder-Root Electronic Line Leak Detection System and/or our pump control Universal Input-Output interface Module (UIOM).

Maxxum STP



Overview

The Red Jacket® Maxxum Submersible Turbine Pump (STP) is intended for 6" high flow applications and provides the industry's highest flow rates. The Maxxum series boasts leading serviceability and safety features. With a 3 or 5 HP motor, it's specifically engineered for high throughput applications such as truck stops, where extreme demand, multiple fuel points, and long piping runs reduce fuel flow to the nozzle.

Product Description

The Maxxum (formerly Big Flo) STPs and Unitized Motor Pumps (UMPs) provide the industry's highest flow rates by reducing the number of restrictions within the flow path. The efficient design also leads to less power consumption, contributing to a lower lifetime cost of operation. Easy access to valves and ports allows for reliable diagnostics and fast service.

▶ KEY FEATURES

- **Reduced Wear** – Enhanced design results in quieter operation and less wear.
- **Improved Insulation Rating** – Higher insulation temperature rating assures longer running life.
- **Increased Protection** – Additional stainless components result in better protection for use with blended fuels.
- **Backwards Compatible** – Maxxum UMPs are compatible with previous 3 and 5 HP Maxxum STPs.
- **Explosion Proof** – Improved design provides increased levels of safety; certified UL/cUL/IECEX/ATEX Explosion proof motor.
- **Continuous Safety Improvements** – Design enhancements guided by newer international flame proofing standards.

Red Jacket 3 and 5 HP Maxxum Performance in Diesel

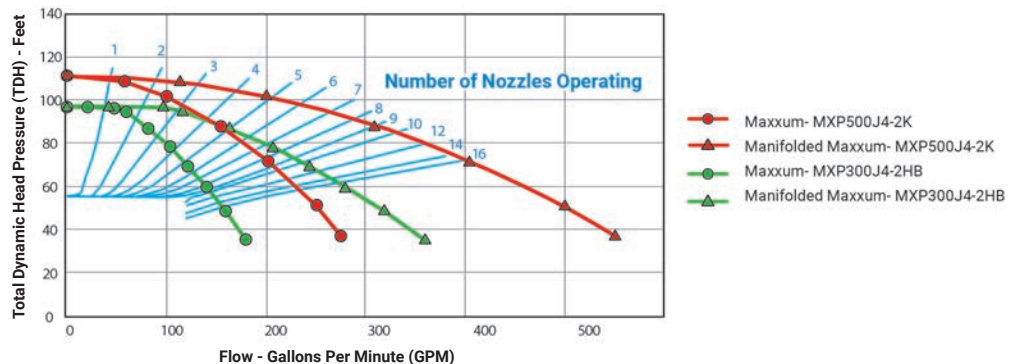



Overview

The Red Jacket® CoreDEF™ STP is an innovative solution that sets a new standard in the optimization of Diesel Exhaust Fluid (DEF) pumping infrastructure. CoreDEF is an entirely customizable DEF delivery system, designed for a complete range of light- to heavy-duty submersible DEF applications.

Various motor sizes, Quick Set® variable lengths, and the only adjustable pressure relief offering on the market, make the CoreDEF pump a flexible solution that can be tailored to maximize value, while controlling cost. The CoreDEF sub DEF pump is pre-assembled and factory leak tested, which cuts out the stress and time of installation and get you pumping sooner.

▶ KEY FEATURES

- The submersible pump and supplied components satisfy the ISO 22241 standard for DEF quality.
- Durable stainless-steel construction for longevity and DEF compatibility.
- Pressure relief valve allows for continuous running and protects motor when nozzles are idle with adjustable pressure relief option available.
- Portfolio of motors available to meet global power or demand requirements for both Single- and Three-Phase.
- Same field proven Quick Set® design as The Red Jacket portfolio.

Factory Leak Tested:

Diesel Exhaust Fluid is extremely hard to contain and even harder to clean up.

- CoreDEF submersible DEF pumps are factory-tested to prevent any possibility of leaks in the field.
- Using a competitive pump may allow leaks and crystallization, seriously complicating serviceability.

Adjustable Line Pressure Relief Option:

Enables the user to adjust line pressure between 20-45 PSI, making for painless post-installation flow rate tuning.

- Optimize operation with any dispenser.
- Avoid excessive nozzle squeeze.
- Prevent nozzle spit back.

Product Compatibility:

- Designed for DEF consisting of 32.5% Urea and 67.5% deionized water.

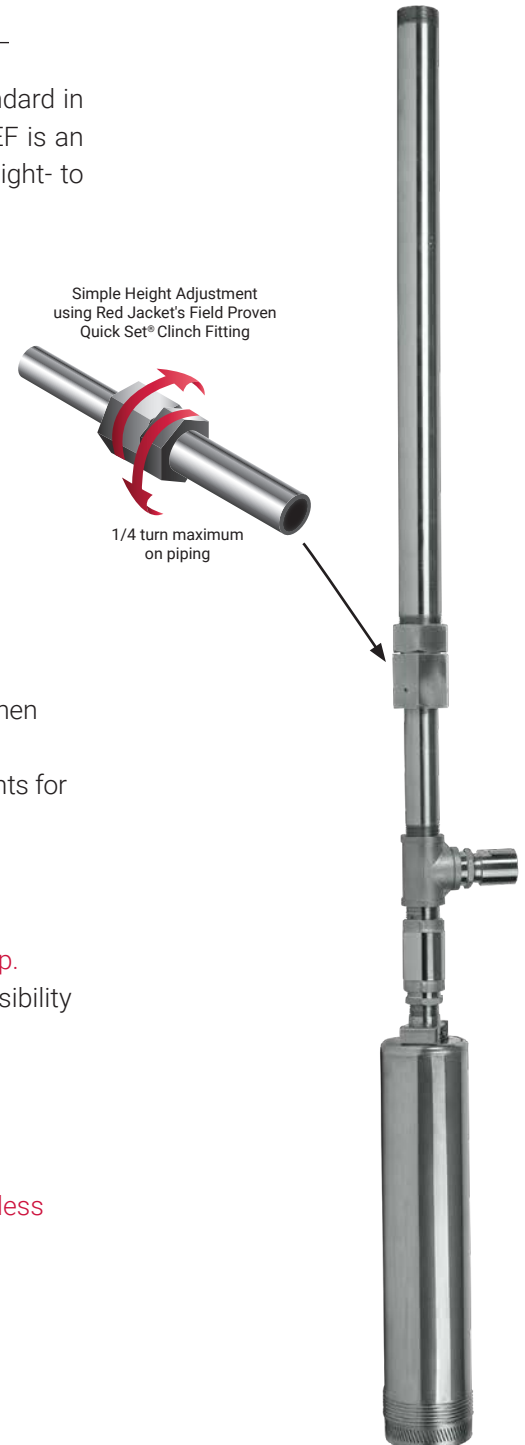

CoreDEF™ STP

Model Portfolio for Varying Applications

The CoreDEF Series Portfolio contains the perfect power setting for your site. Model selection is made easy using the guide below:



**2 HP Submersible Application
(Model Number - DP200):**

- Fits sites with 3 – 7 fueling points
- Available in Single- or Three-Phase options



**¾ HP Submersible Application
(Model Number - DP75):**

- Fits sites with 1 – 2 fueling points
- Available in Single-Phase

► **FIXED LINE PRESSURE RELIEF OPTION**

Easy out-of-box installation to protect your fueling system from excessive pressure.

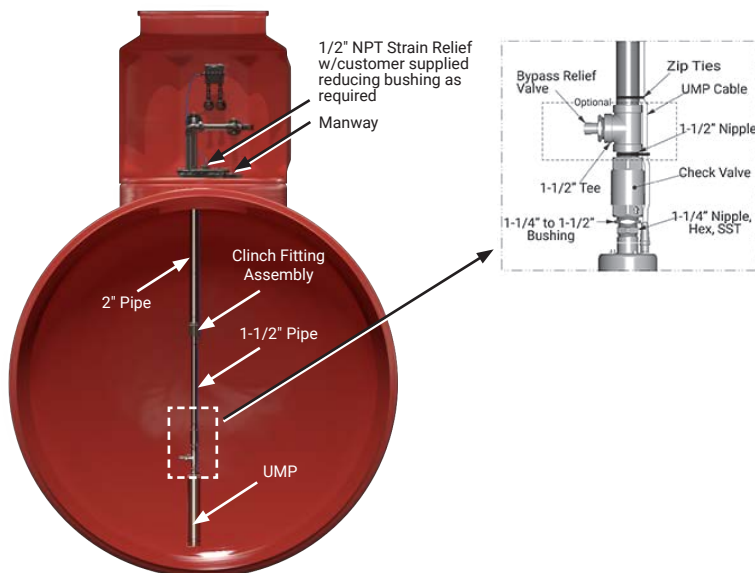

► **EXTREME DEMAND?**

CoreDEF STPs can easily be manifolded together to double throughput and meet high demand requirements.





Site Configuration

► STEP 1: Final Assembly Configuration

Final Assembly Configuration Builder						Adjustable Pressure Relief Kits	
A UMP Size (HP)	B Phase	C Type of Pressure Relief	D Adjustment Range - See Manual Diagram	E Final Assembly Description	F Final Assembly P/N	G Adjustable Pressure Relief Kit P/N 410881-001	H Check Valve P/N 410875-001
3/4	1	Fixed	D1: 66.0" - 97.0"	DP75U1-D1 w/ relief	410870-001	Not Required	
			D2: 96.0" - 157.0"	DP75U1-D2 w/ relief	410870-002		
	Adjustable	D1: 66.0" - 97.0"	DP75U1-D1 w/o relief	410870-005	Required	Recommended ¹	
		D2: 96.0" - 157.0"	DP75U1-D2 w/o relief	410870-006			
2	1	Fixed	D1: 73.0" - 104.0"	DP200U1-D1 w/ relief	410870-009	Not Required	
			D2: 103.0" - 164.0"	DP200U1-D2 w/ relief	410870-010		
		Adjustable	D1: 73.0" - 104.0"	DP200U1-D1 w/o relief	410870-013	Required	Recommended ¹
			D2: 103.0" - 164.0"	DP200U1-D2 w/o relief	410870-014		
	3	Fixed	D1: 73.0" - 104.0"	DP200U4-D1 w/ relief	410870-017	Not Required	
			D2: 103.0" - 164.0"	DP200U4-D2 w/ relief	410870-018		
		Adjustable	D1: 73.0" - 104.0"	DP200U4-D1 w/o relief	410870-019	Required	Recommended ¹
			D2: 103.0" - 164.0"	DP200U4-D2 w/o relief	410870-020		

¹ Note: Adjustable Pressure Relief Option can be operated without a check valve, but will allow the system to depressurize to 0 PSI between dispense cycles. Line depressurization will not be noticed while dispensing. Finals with fixed pressure relief include a check valve in the piping assembly.

► STEP 2: Control Box Configuration

A Control Box is recommended to activate the pump in response to a dispense request. In **Single-Phase applications**, the Control Box houses the Pump Start Capacitor. (Not required for Three-Phase.)

Control Box Configuration (Includes integrated capacitor for single-phase)				
A Hook Signal Voltage	B Phase	C UMP Model	D Control Box P/N	E Control Box Description
120V	1	DP75 (3/4 HP)	880-045-5	Standard Control Box 17.5uF 120VAC for 3/4 HP
		DP200U1 (2 HP)	410861-001	Standard Control Box 40uF 120VAC for 2 HP
	3	DP200U4 (2 HP)	410648-001 & 410649-010	Magnetic Starter 115VAC for 3 Phase & (qty. 3) Heaters 2 HP 60Hz



Control Box

► STEP 3: Isotrol™ Box Configuration

The Isotrol Box is optional for sites that require dispenser hook isolation.

Isotrol Box Configuration			
A Hook Signal Voltage	B Manifold Pumps?	C Isotrol Part Number ¹	D Isotrol Description
120V	Yes	880-047-1	Isotrol 120v w/ relay
	No	880-049-1	Isotrol 120v w/o relay

¹ Note: An Isotrol *with relay* is utilized to activate the second pump when operating manifolded pumps. Reference the CoreDEF Installation Manual (577014-360).



Isotrol Control Box

► Piping Accessories

If you are using the Adjustable Pressure Relief Valve, considering a DEF Recirculation system or expanding an existing site. Select optional plumbing accessories based on the following scenarios.

Optional Piping Accessories			
Pressure Gauge		NPT to BSP Adapters	
Need Gauge for Pressure Tuning? ¹	Recommended Pressure Gauge ³	Need to transition from NPT to BSP?	NPT to BSP Adapter
Using Adjustable Pressure Relief?	410880-001 (¼" NPT fitting)	No	Not Required
Using DEF Recirculation? ²		Female 1½" BSP	410878-001
		Female 2" BSP	410879-001

¹ Note: Additional information can be found in the DEF Recirculation Installation Manual.

² Note: DEF recirculation was developed as a solution for DEF sites affected by extreme temperature conditions.

³ Note: Though not required, a pressure gauge (P/N: 410880-001) can be used in any CoreDEF application.



The Red Jacket DEF Pump

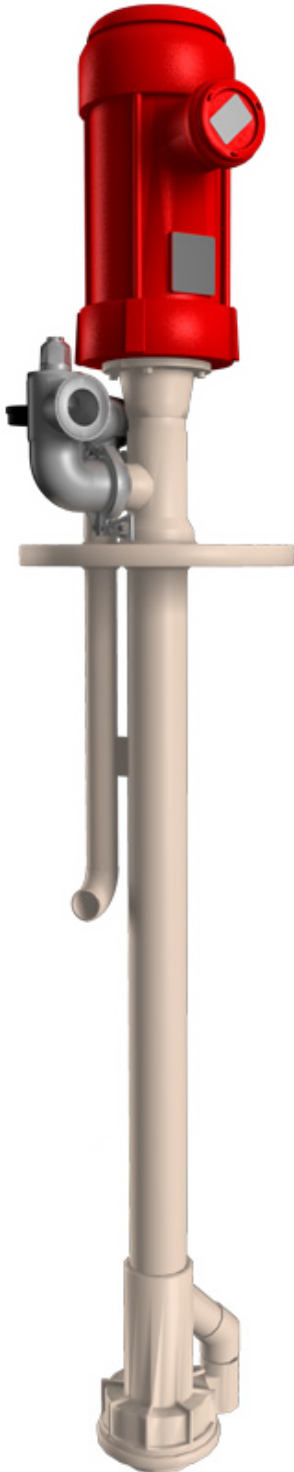

Red Jacket Delivers More Flow

The Red Jacket® DEF Pump is a complete fueling solution designed to deliver the highest flow and maximum performance for sites that dispense Diesel Exhaust Fluid (DEF). The Red Jacket DEF Pump combines the benefits of Red Jacket's pressure technology with unique design features to deliver DEF more quickly, safely and reliably than any other pump.

When tested head-to-head against other pumps used for DEF, the Red Jacket DEF Pump delivered more flow, even under the most extreme conditions. Capable of supporting underground or aboveground piping-runs without reduced flow performance, Red Jacket's DEF Pump delivers two times more flow than other DEF solutions above 7 fueling points and greater than 55% more flow overall. For sites with 1 - 7 DEF dispensing points, try the Red Jacket CoreDEF™ STP.

► KEY FEATURES

High Flow:

- Provides two times more flow than other submersible DEF pumps above 7 fueling positions and greater than 55% more flow overall.

Maximum Reliability:

- Stainless steel shaft and core encased in polypropylene shield provides the optimal balance of structural integrity, corrosion resistance, and weight.
- Advanced motor capable of handling more than 30 start/stop cycles per hour for busy sites.
- Two thermal overloads provide motor protection.

Easy Service:

- Motor above tank eliminates the need to open the tank or break hydraulics during service, saving time and avoiding DEF spillage onto forecourt.
- Integrated check valve can be locked down for line tests or service and lifted to drain non-isolated product back into the tank.

Protects DEF Quality:

- Motor does not come into contact with DEF, avoiding risk of overheating or contaminating highly sensitive DEF.
- Tank does not have to be opened during motor service, preventing debris or water from entering the tank.

Fuel Compatibility:

- Compatible with DEF - 32.5% Urea, 67.5% deionized water.
- Meets ISO 22241 Requirements.



Overview

The Red Jacket® Liquefied Petroleum Gas (LPG) Premier range of STPs meet a wide variety of site configurations and demands for high flow performance, durability and adaptability, while maximizing profitability. Compatible with butane, propane, or any blend of the two, these multistage centrifugal pumps supply exceptional performance at peak efficiency. The LPG Premier STPs are the industry's most efficient, cost-effective explosion-proof submersible pump/motor units, designed to pump LPG.

The Premier and Premier MidFlow are designed for standard LPG refueling applications with low to intermediate flow requirements, while the Premier HiFlow is intended for high capacity installations such as commercial vehicle fueling facilities and LP cylinder filling plants.

Product Description

LPG is a mixture of gasses, primarily propane and butane and remains a vapor until pressurized to the point of liquification. The LPG Premier Series operates under sufficient pressure to retain the liquid state at optimal delivery rates.

This multi-stage technology provides maximum performance with efficient energy consumption:

- 2.25 kW (3 hp) for the Premier pump
- 2.25 kW (3 hp) for the MidFlow pump
- 3.75 kW (5 hp) for the HiFlow pump

A floating impeller design eliminates unnecessary resistance and maximizes flow. All diffusers are interlocked and are enclosed in a stainless steel shell.

Staging consists of three ruggedized components:

1. The diffuser
2. The diffuser plate
3. The impeller

The Premier series controls motor temperature using an innovative internal bleed (by-pass) in the motor. Motors meet all flameproof requirements per DEMKO 13 ATEX 9483031U and IECEx UL 13.0034U certificates. The minimum differential pressure requirement for The Red Jacket Premier Series LPG pumps is 400 kPa (58 PSI).

The Red Jacket Premier Series LPG pumps requires at least 127 mm (5.0 inches) of submersion (or Net Positive Section Head).

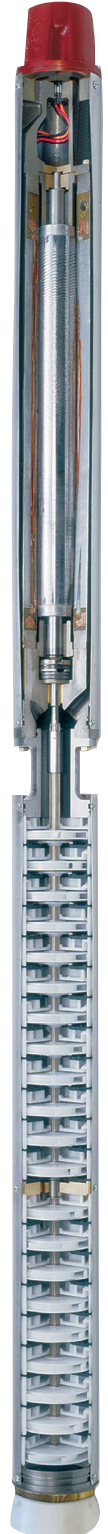

Combat Corrosion

Combat In-Sump Corrosion

Why is Corrosion of In-Sump Equipment an Issue?

Corrosion of equipment in sumps causes deterioration and shortens its useful life span. As corrosion advances it has the potential to affect the integrity of piping and electrical systems, and the serviceability of submersible turbine pump equipment.

Corrosive conditions are caused when three common components are present:

- Ethanol Vapors
- Water
- Bacteria

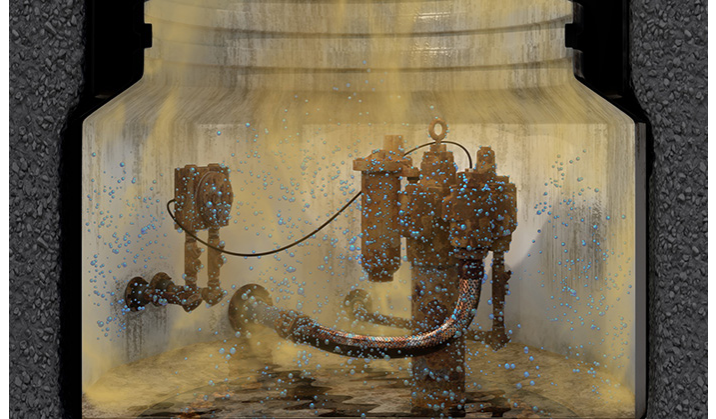

Categories of Observed Fuel Corrosion

Vapor Space Corrosion In-Sump

- Affects of ethanol-blended fuels
- Damages 'above-the-line' in the vapor space, ullage space in UST, and sump space

Microbial Induced Corrosion in the UST

- Affects of ULSD fuels
- Damages 'below-the-line' wetted surfaces UST, in-tank equipment, piping, shear valves
- Accompanied by microbial 'sludge' growth





Protect In-Sump Equipment From Corrosion

The Red Jacket® Sump-Dri™ Desiccant System uses a specifically formulated desiccant blend that protects equipment in the STP sump from corrosive conditions. The Sump-Dri Desiccant System should be installed in sump spaces that frequently have increased moisture or ethanol vapors. Any moisture in the sump, whether it be high humidity, condensation or water ingress, can combine with ethanol vapors to create conditions for corrosion. Sump-Dri keeps the sump in better condition and ensures longer life of parts contained in the sump.



Up to 6 Months of Protection

Sump-Dri units are expected to protect a 75-100 cu.ft. space for up to 6 months under typical conditions, but functional duration may be shorter or longer depending on humidity level, temperature, how well the sump is sealed, and frequency that the sump space is opened. Larger spaces or extended maintenance periods may elect to install multiple units. Sump-Dri units should be changed when the desiccant in the upper chamber has completely depleted.

Field Test Results

At the conclusion of a year long study the results were clear:

Sites with the Sump-Dri installed had more sustainable conditions within the sump space, including limited condensation on the equipment, reduced levels of humidity and low acetic acid concentration in the vapor space. In sump spaces that were not installed with the Sump-Dri at the same site, accelerated corrosion on the equipment, extreme condensation, high levels of humidity and high acetic acid concentrations were all present.

Regular Unleaded Without Sump-Dri Installed



1



2

Regular Unleaded With Sump-Dri Installed

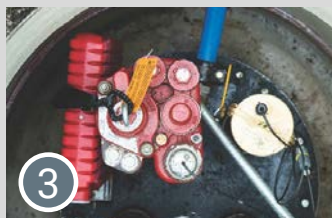

3

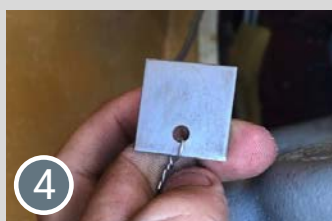

4

- 1 Extreme Corrosion
- 2 Test Coupon Fully Corroded
- 3 Dry & Clean
- 4 Test Coupon Clean

Sump-Dri™ Desiccant System

Visualize Corrosion

- Corrosion is 'controlled' if humidity levels below 60% are maintained³. If humidity is greater than 60%, corrosion will not be controlled and will be accelerated with the presence of ethanol vapors.
- Depending on the conditions in a specific sump, there are a number of different solutions to help mitigate the effects of corrosion and reduce the likelihood that it will occur.

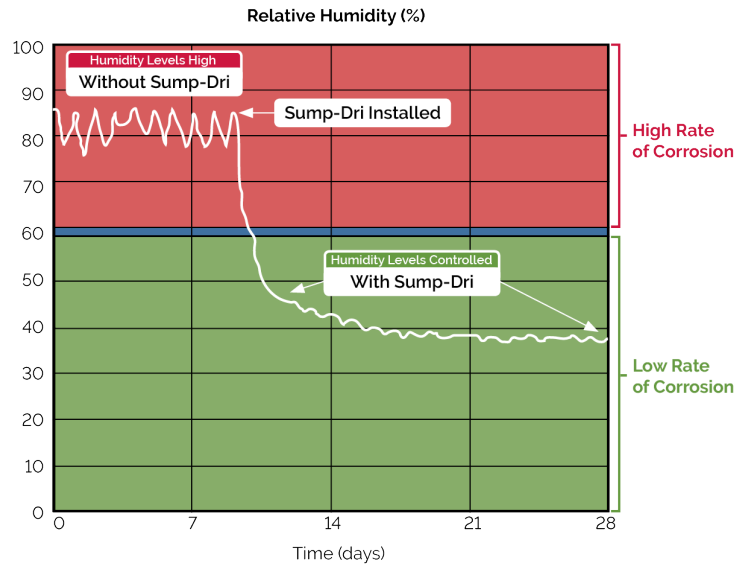

Ideal Conditions

Suitable Conditions & Requirements for Optimal Sump-Dri Performance Usage

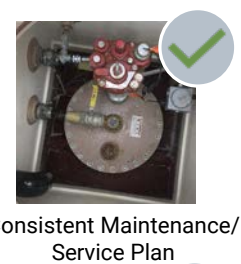
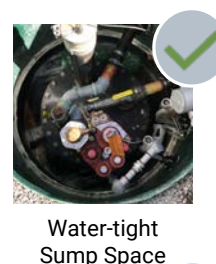
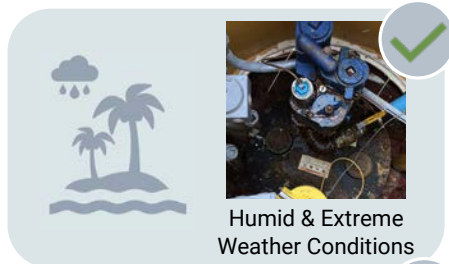

Conditions Not Suitable for Sump-Dri Installation

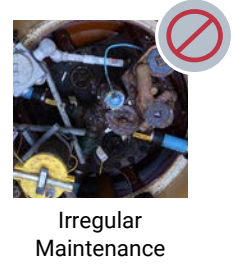
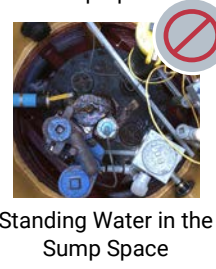



The Red Jacket Stainless Steel Riser Pipes

Corrosion Defense

The Red Jacket® Stainless Steel Riser Pipes are impervious to in-sump corrosion caused by acetic acid. They improve submersible turbine pump (STP) serviceability in corrosive environments and avoid water intrusion into your tank from corroding riser pipe threads.



Take a Stand Against Rising Water

If the sump frequently has standing water and water in the tank is an issue, consider installing 4" Red Jacket Stainless Steel Riser Pipes, Type 304, NPT thread, in all new and reconfigured submersible turbine pump applications.

Red Jacket Stainless Steel Riser Pipes address water intrusion at tank top interfaces due to accelerated corrosion of riser pipe threads in damp sumps.

Specify "omit riser" on any STP final order and add the properly sized stainless steel riser on any Red Jacket STP order to replace the standard material riser with the stainless-steel version.

► **NOTE:**

- Replaces standard 4" riser pipes, 7.5", 10.5", 12.5", 15.5", 19.5", and 27.5" lengths in-stock and additional lengths available upon request.



Trapper Intake Screen

Overview

The Red Jacket® Trapper Intake Screen is the first line of defense against debris from microbial induced corrosion or other harmful particulate from entering the site fueling system.

Prolong fueling equipment life and save money with the Red Jacket Trapper Intake Screen. Unique, triangular slot design prevents accumulation and lodging of particles from underground storage tanks, maintaining peak performance of the submersible pump and keeping debris from entering the site's fueling system and dispensers. The Red Jacket Trapper Intake Screen is the perfect accessory to the industry leading line of submersible turbine pumps (STP) provided by Red Jacket.

How The Red Jacket Trapper's Unique Screening Action Works

Pump ON: The triangular design of the filter allows the free flow of fluid but blocks particulate from entering the fluid system without reducing pump performance.

Pump OFF: Self-cleaning design allows particulate to fall away from the intake when the submersible pump is turned off.

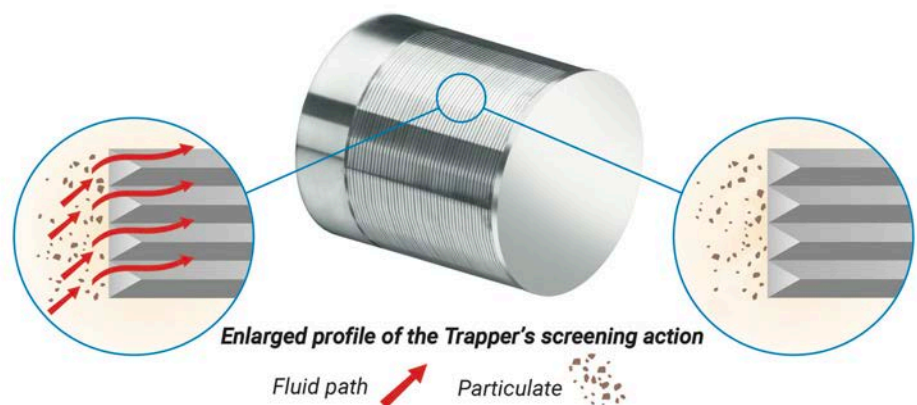

▶ KEY FEATURES

- High-quality continuous slot design specifically engineered to fit at the end of the Red Jacket STPs. Available as a field retrofit kit for Red Jacket STPs.
- Easy, low cost retrofit kit makes the Red Jacket Trapper Intake Screen a money saver at any Red Jacket site.
- Triangular profile screen blocks tank particulates from entering the pump.
- Self-cleaning every time the submersible pump is turned off.
- Rugged 304 stainless steel construction.
- Protects STPs from rags and other larger debris.
- Reduces submersible intake filter changes to as low as once per year per line, saving on labor and filter costs by preventing tank particulates from entering the fluid system.
- Decreases environmental liability by reducing the potential for filter seal leaks due to frequent filter changes.
- Reduces the amount of hazardous waste generated by used filters.
- Non-clog design does not require scheduled maintenance.
- Prolongs dispenser life.



Control Boxes



Standard Control Box Pump Control Box

Maintain safe, reliable, efficient fuel flow with Red Jacket's most basic submersible turbine pump interface. Our Standard Control Box interfaces between the fuel dispenser and the turbine pump and has an indicator light that signals when a customer begins fueling.



IQ Smart Control Box Pump Control Box

Red Jacket's IQ Control Box is a submersible turbine pump interface that improves the longevity of the submersible pump motor. It's engineered to provide protection from dry-run conditions, locked rotor and site voltage fluctuations. It cuts downtime and boosts bottom line profits by warning site personnel of conditions impacting the ability to fuel. Plus, it meets fuel flow requirements, provides seamless backup and extends motor life by staging multiple pumps based on site fuel demand.



ISOTROL™ 1-8 Control Box Dispenser Hook Isolation Box

The Red Jacket ISOTROL 1-8 Control Box is the most versatile dispenser handle signal isolation system available. It isolates handle signals between each dispenser and protects against wiring shorts and phasing issues. Plus, it keeps technicians working on-site safe from dangerous feedback. The ISOTROL 1-8 Control Box is available with a built-in relay or without.

▶ KEY FEATURES

- Easy interface between dispenser and turbine pump
- Enables "lock-out-tag-out" for safe pump servicing
- Available with internal capacitor for ease of troubleshooting and repair, saving time and money

▶ KEY FEATURES

- Allows for demand-based staging of multiple pumps to control fuel flow based on changing fuel demand
- Automatically resets after dry run condition when fuel is added to the tank to minimize downtime
- Protects wiring and controls from locked rotor or high current
- Warns site personnel of conditions impacting the ability to fuel
- Monitors site power conditions to ensure long motor life and uninterrupted fueling

▶ KEY FEATURES

- Dedicated Automatic Tank Gauge (ATG) line leak output and coil for easy compatibility with PLLD
- Terminals are labeled for easy wiring and compatibility
- Compatible with Red Jacket's Submersible Turbine Pump, Maxxum, IQ Control Box, or as a stand-alone
- Easily retrofitted to existing locations
- Compliant with NEC requirements for handle isolation



IQ Smart Control Box



Overview

- The amount of current a STP draws is proportional to the flow rate
- IQ Control Box stages on a second pump when demand is high
- IQ Control Box will also call for help when it senses a fault

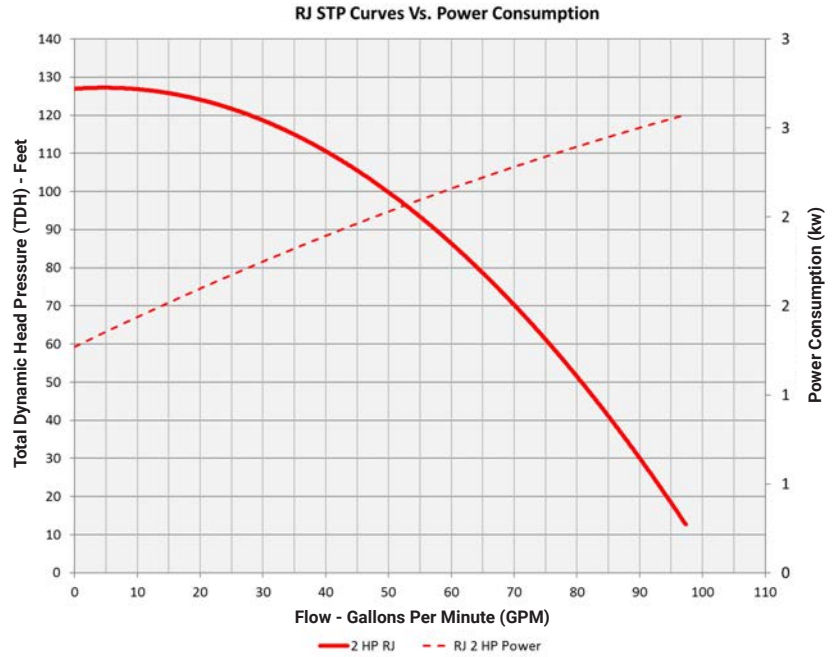



The Red Jacket 2 HP STP Fixed Speed Conversion Kit

Focused on Reliability

Red Jacket’s unsurpassed expertise helps your customers optimize fuel flow. Focused on reliability and quality, The Red Jacket STP Fixed Speed Conversion Kit ensures that your customers have the most optimal system to pump fuel quickly, efficiently and safely – whether it’s motor fuel, diesel, aviation gasoline, ethanol/methanol or kerosene – in aboveground or underground storage tanks.

In order to convert from a FE Petro three phase, variable speed pump to a Red Jacket single phase, fixed speed pump, you need one of the following conversion kits. You have the option to install the capacitor in the packer manifold or in the Standard or IQ control box depending on preference.



Capacitor Location	Control Box Type	Voltage	Conversion Kit Part Number
Capacitor Included in Red Jacket Control Box	Standard Control Box	120V	410893-003
	IQ Control Box	120V	410893-007
Capacitor to be Installed in FE Petro STP Junction Box	Standard Control Box	120V	410893-001
	IQ Control Box	120V	410893-005

- 1 410893-003:** Standard Control Box with capacitor included (410861-001)
- 2 410893-007:** IQ Control Box with capacitor included (880-058-1)
- 3 410893-001:** Standard Control Box (880-041-5) with separate Capacitor Kit (410901-001)
- 4 410893-005:** IQ Control Box (880-051-1) with separate Capacitor Kit (410901-001)

1 410893-003



Capacitor in Standard Control Box
410861-001

2 410893-007



Capacitor in IQ Control Box
880-058-1

3 410893-001



Standard Control Box
880-041-5

and



Capacitor Kit
410901-001

4 410893-005



IQ Control Box
880-051-1

and



Capacitor Kit
410901-001

Included in All Kits:



4" Pigtail 20-Foot Kit
410156-001

NOTICE:

THIS PUMP HAS BEEN MODIFIED PER V-R MANUAL 577014-365 AND NOW UTILIZES A VEEDER-ROOT UMP, PIGTAIL, AND CONTROL BOX.

Identification Plate
410917-001



Installation Manual
577014-365

Included in All Kits

- 4" Pigtail 20-Foot Kit (410156-001)
- Identification Plate with Attachment Wire (410917-001), to be tied around FE Petro yoke
- Installation Manual (577014-365)

UMP Sold Separately

- UMP200U1-3 Petroleum UMP
- AGUMP200S1-3 Alcohol Gas UMP

FXV Series Mechanical Line Leak Detectors

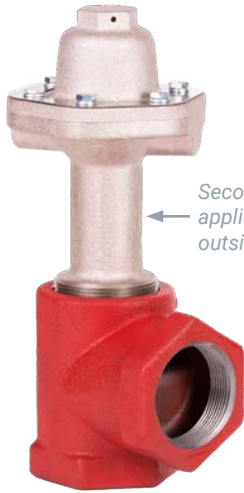

Secondary application outside of STP.

MLLD accessory for external install.



The Red Jacket STP with FXV MLLD vacuum break installed.

Fuel Compatibility for all models of the FXV Leak Detector are UL Listed:

- 100% Diesel
- 100% Gasoline
- Gasoline and up to 10% Ethanol

Overview

Red Jacket® FXV Mechanical Line Leak Detectors (MLLD) are permanently installed in the fuel line, and continuously performs 3 gal/h testing. If a leak is detected, fuel flow is restricted continuously to the dispensers.

Product Description

Red Jacket FXV Mechanical Line Leak Detectors are built for superior performance and keeping operators in compliance – even in the most challenging environments. They offer the fastest Mechanical line leak test available for hourly monitoring – the most cost-effective and reliable means to meet U.S. Federal Environmental Protection Agency catastrophic line leak detection requirements – and are guaranteed for two full years. FXV Leak Detectors are UL listed and third party certified to ensure quality, performance, and durability.

► KEY FEATURES

- UL listing: 100% diesel, 100% gasoline, gasoline and up to 10% ethanol.
- Meets EPA requirements in environments that experience extreme temperature changes.
- Robust design that works effectively in the most common and difficult testing environments.
- Adapts to applications using high-resiliency lines, such as flexible piping.
- Handles up to 11 feet of static head.
- Installs and troubleshoots without requiring special tools.
- Guaranteed to detect at a rate of 3 GPH at 10 PSI for 24 months from date of manufacture.
- Can be used with any Red Jacket or competitive submersible turbine pump.



Gas



Diesel



Electronic Pressurized Line Leak Detection System

Overview

The Veeder-Root Electronic Pressurized Line Leak Detection (PLLD) system can be used in a variety of pressurized line applications. Our patented technology performs leak test at full pump pressure for 0.1 gph precision and a pressure decay test to meet the US EPA continuous 3.0 gph gross test requirement. When partnered with our TLS-450PLUS ATG, large volume customers can now monitor lines that exceed 1,100 gallons.



► KEY FEATURES

- Proven pressure transducer technology
- No restriction of fuel flow
- Utilizes Swift Check Valve on early generation Red Jacket (Standard) Submersible Pumps
- Test lines at full pressure for quick and accurate result
- Standard 3.0 gph, Optional 0.2 and 0.1 gph testing
- Not impacted by thermal contraction of fuel
- Installs without breaking piping or adding a new sump
- Supports a wide-range of pump and pipe types
- Several options based on TLS system
- Pressure Sensor constructed with stainless steel to meet the challenges of a highly corrosive environment

Fuel Compatibility for all models of the Electronic Pressurized Line Leak Detection System:

- Unleaded Gasoline
- Leaded Gasoline
- 5% Methanol
- Up to 100% Ethanol
- 15% MTBE
- Diesel
- Biodiesel (Up to B100)
- Kerosene
- Jet Fuel
- Aviation Gasoline

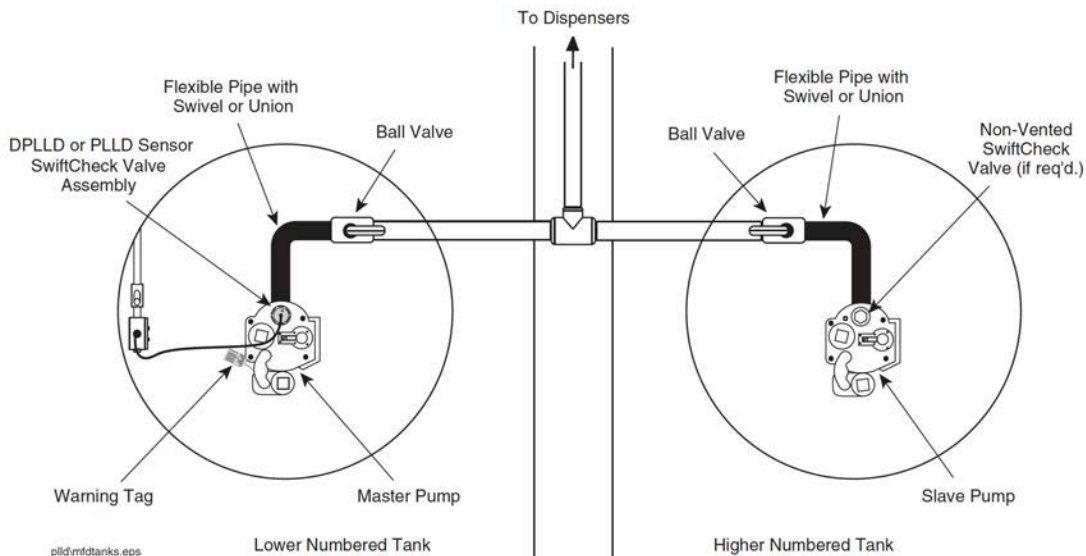



Vacuum Breaker



Overview

The Red Jacket® Vacuum Breaker Accessory helps prevent restricted fuel flow by eliminating the vacuum created by extreme thermal contraction conditions. Breaking the vacuum means faster fueling for your customers. The Vacuum Breaker offsets product shrinkage by releasing up to 1.2 quarts (1,100 ml) of product into the line, resulting in quicker opening times of mechanical leak detectors.

▶ KEY FEATURES

- Helps prevent restricted fuel flow – and frustrated customers – by eliminating the vacuum created by extreme thermal contraction conditions.
- Offsets product shrinkage by releasing up to 1.2 quarts (1,100 ml) of product into the line, resulting in quicker opening times of mechanical leak detectors.
- Installs easily to packer assembly using existing packer manifold mount.



Архангельск (8182)63-90-72
Астана (7172)727-132
Астрахань (8512)99-46-04
Барнаул (3852)73-04-60
Белгород (4722)40-23-64
Брянск (4832)59-03-52
Владивосток (423)249-28-31
Волгоград (844)278-03-48
Вологда (8172)26-41-59
Воронеж (473)204-51-73
Екатеринбург (343)384-55-89
Иваново (4932)77-34-06

Ижевск (3412)26-03-58
Иркутск (395)279-98-46
Казань (843)206-01-48
Калининград (4012)72-03-81
Калуга (4842)92-23-67
Кемерово (3842)65-04-62
Киров (8332)68-02-04
Краснодар (861)203-40-90
Красноярск (391)204-63-61
Курск (4712)77-13-04
Липецк (4742)52-20-81
Киргизия (996)312-96-26-47

Магнитогорск (3519)55-03-13
Москва (495)268-04-70
Мурманск (8152)59-64-93
Набережные Челны (8552)20-53-41
Нижний Новгород (831)429-08-12
Новокузнецк (3843)20-46-81
Новосибирск (383)227-86-73
Омск (3812)21-46-40
Орел (4862)44-53-42
Оренбург (3532)37-68-04
Пенза (8412)22-31-16
Казахстан (772)734-952-31

Пермь (342)205-81-47
Ростов-на-Дону (863)308-18-15
Рязань (4912)46-61-64
Самара (846)206-03-16
Санкт-Петербург (812)309-46-40
Саратов (845)249-38-78
Севастополь (8692)22-31-93
Симферополь (3652)67-13-56
Смоленск (4812)29-41-54
Сочи (862)225-72-31
Ставрополь (8652)20-65-13
Таджикистан (992)427-82-92-69

Сургут (3462)77-98-35
Тверь (4822)63-31-35
Томск (3822)98-41-53
Тула (4872)74-02-29
Тюмень (3452)66-21-18
Ульяновск (8422)24-23-59
Уфа (347)229-48-12
Хабаровск (4212)92-98-04
Челябинск (351)202-03-61
Череповец (8202)49-02-64
Ярославль (4852)69-52-93

<https://redjacket.nt-rt.ru/> || rtp@nt-rt.ru

